

Look At the Playground

Color the playground and count.

What do you want to play on? I want to play on the ____.

Do you want to play on the ____? Yes, I do.

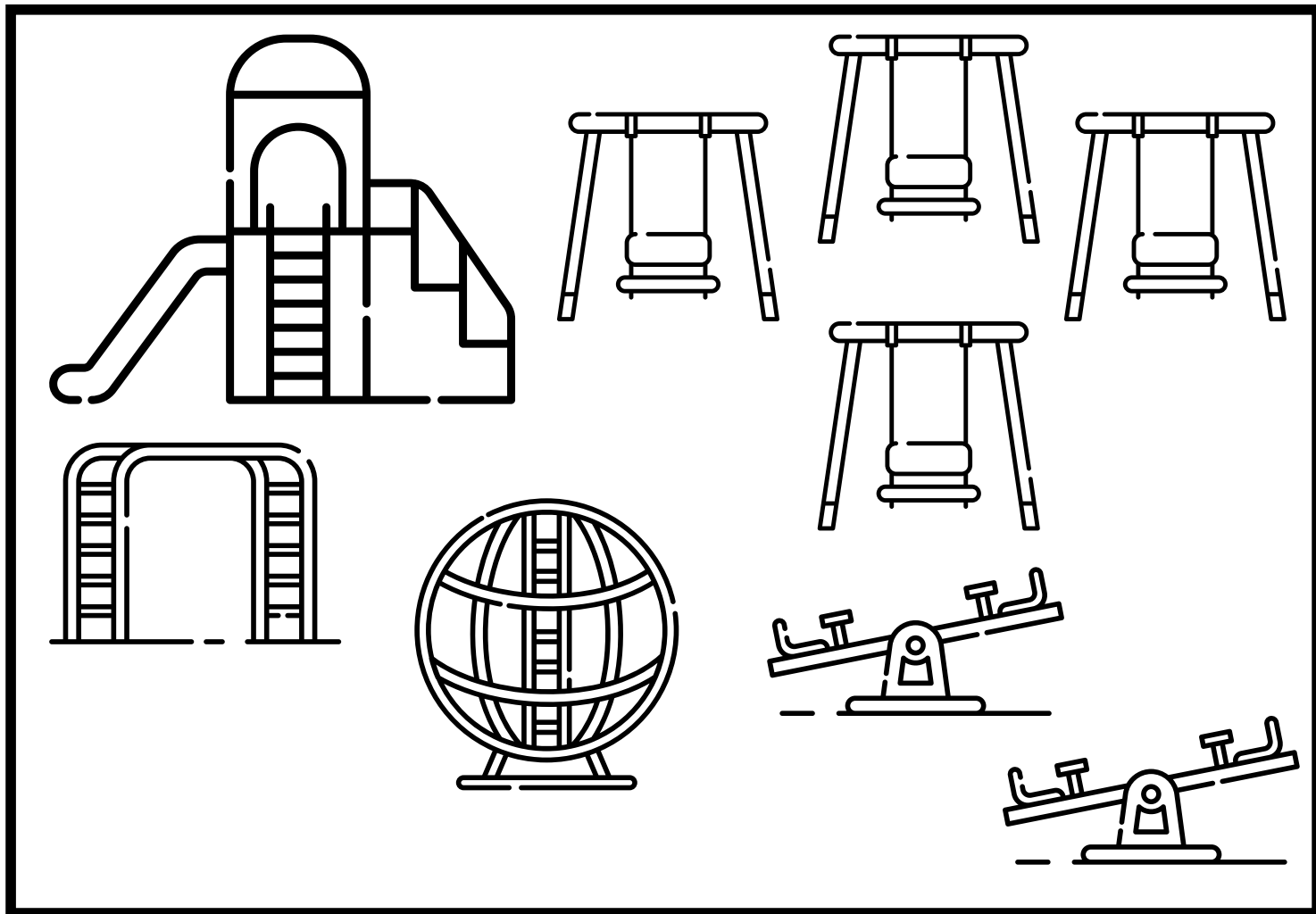

I see _____ on the playground.

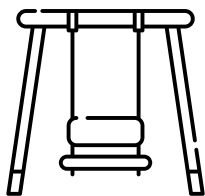

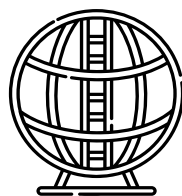

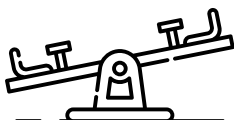

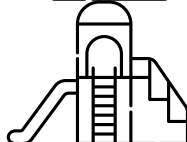

Name

BOOSTER

B3 U5 - At the Playground 1

At the Playground

Read the sentences and draw the people.

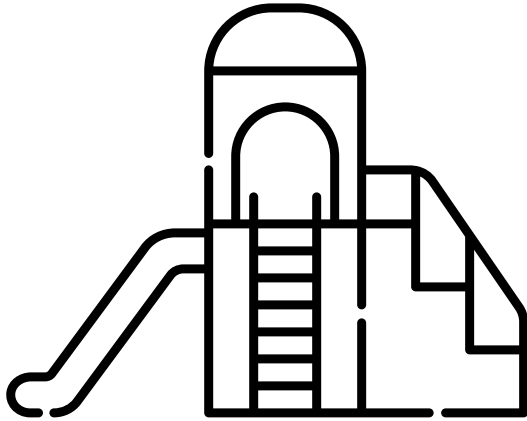

She is on the slide.

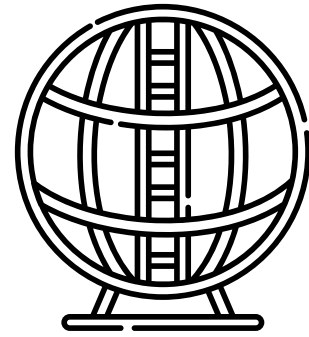

He is on the jungle gym.

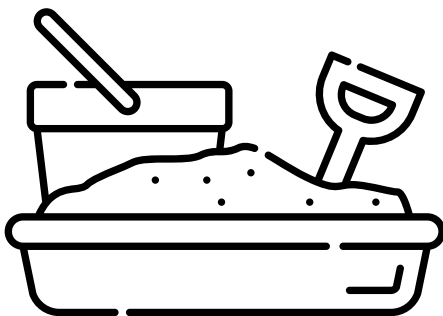

He is in the sandbox.

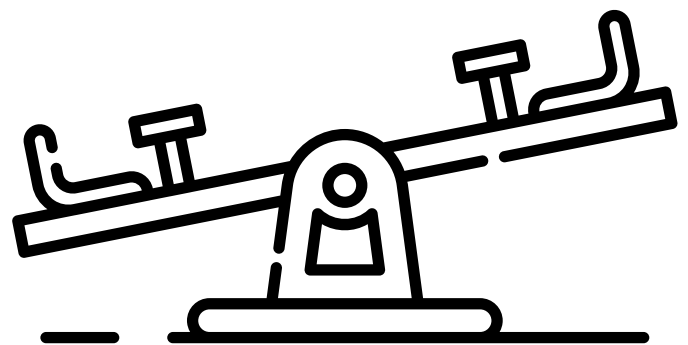

She is on the seesaw.

Name

B^o_sTER

B3 U5 - At the Playground 2

Draw Pictures

Which one can you climb / sit on? Draw it.

I can climb / sit on ___?

Climb

Sit

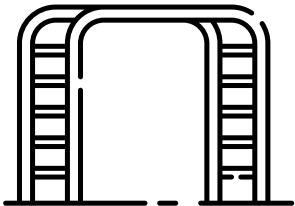

Monkey bars



Jungle gym

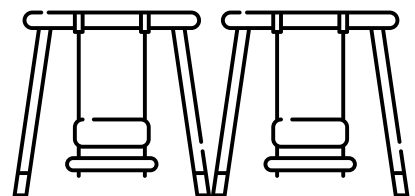

Swings

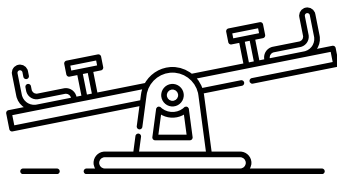

Seesaw

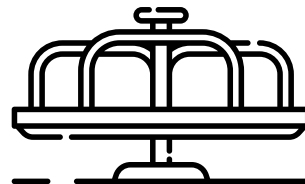

Merry-go-round

Name

B⁰_STER

Simple Machines

Read the words and number the pictures.

A Read the words.

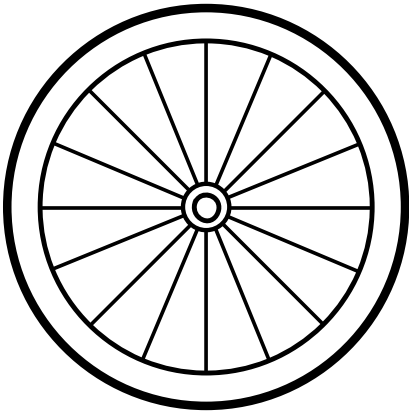

1 wheel

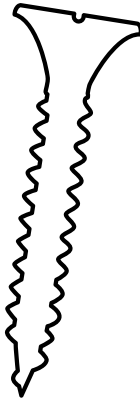

2 screw

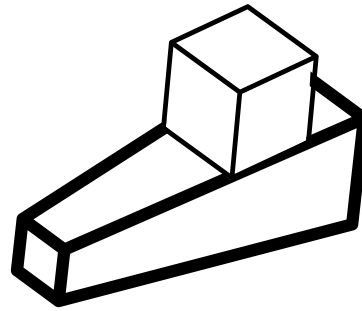

3 plane

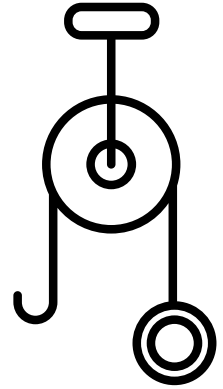

4 pulley

B Number the pictures.

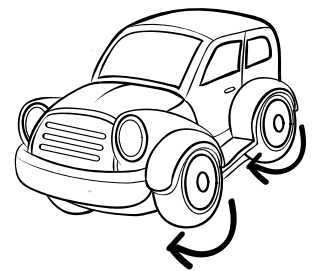
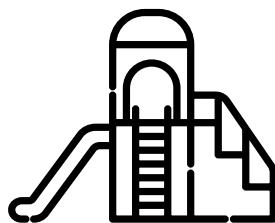
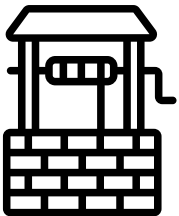

Name

BOSTER

B3 U5 - At the Playground 4